

## Product Manual



### Important Safety Instructions

Read all warnings and instructions in this manual. Save all instructions.



**Advantage Controls**  
4700 Harold-Abitz Dr.  
Muskogee, OK 74403  
Phone: (918) 686-6211  
Fax: (888) 686-6212  
[www.advantagecontrols.com](http://www.advantagecontrols.com)  
E-mail: [support@advantagecontrols.com](mailto:support@advantagecontrols.com)

# LIFTX Lift Station Monitor

## Instruction & Maintenance Manual

### Table of Contents

Contents	Page
I. Introduction.....	3
Model Numbering .....	3
Description of Unit / Control Functions.....	3
II. Installation .....	4
Mounting Instructions .....	4
Electrical Wiring.....	4
Wiring Diagrams .....	4
III. Front Panel Description .....	7
IV. System Operation Overview.....	8
V. Menu Navigation.....	8
VI. Web Advantage Setup.....	17
VII. USB Functions.....	20
VIII. Additional mA Sensor Wiring .....	23
IX. Troubleshooting.....	24
X. Warranty & 30 Day Billing Memo Policy .....	24

#### **FCC Warning**

This equipment generates and uses radio frequency energy and if not installed and used properly, that is, in strict accordance with the manufacturer's instruction, may cause interference to radio communications. It has been type-tested and found to comply with the limits for a class A computing device pursuant to subpart J of part 15 of FCC Rules, which are designed to provide reasonable protection against such interference when operated in a commercial or industrial environment. Operation of this equipment in a residential area is likely to cause interference in which case the user, at his own expense, will be required to take whatever measures necessary to correct the interference.

## I. Introduction

LIFTX microprocessor-based lift station monitors are designed to provide a wide range of lift station monitoring functions. The monitor is programmed through a front panel keypad, or via the Internet through WebAdvantage, and can be configured to provide customized monitoring and alarm notifications for your application through the web. Your particular unit's functions can be determined by comparing the units model number to the Model Numbering table listed below.

### Model Numbering

LIFTX units have several base system control functions and unit optional features. Your unit may be supplied with one or more of the features described in this manual. To determine what features apply to your unit check the model number label located on the controller enclosure.

#### Options

- A24** - 24 VDC power supply for mA inputs
- D** - Blue poly mounting panel (18"T x 20"W)
- D1** - Mounts LIFTX inside MULTI-BOX (17"W x 14"H x 9"D)
- D2** - Mounts LIFTX inside a Fibox (12"W x 14"H x 8"D)
- L** - (5) additional digital alarm inputs
- N4** - (4) 4-20mA isolated inputs
- N8** - (8) 4-20mA isolated inputs (O4 is not available with the N8 option)
- O4** - (4) 4-20mA isolated outputs
- R** - Adds 5 control relays, 120 VAC with pigtails, and mounts cell router in external enclosure
- S** - Delayed cell service start (up to 4 months)
- S1** - AT&T™ service instead of Verizon™ (no delayed start available)
- S2** - Cell router only, with no 12 months of data or SIM card
- W4** - (4) totalizing flow meter inputs with volume tracking and alarming

The model number starts with LIFTX followed by the desired options (Example: **LIFTX-N4**).

#### NOTES:

1. Base LIFTX units have 5 digital inputs, a built-in cell router, and 12 months of data.
2. All units include 10 customizable notepad fields for manual reading test entry. These entries can generate alarms and are stored historically for graphing and reporting.
3. All units come standard with conduit connections for incoming power.
4. All required sensors must be sourced separately.

### Description of Unit

LIFTX monitors provide WebAdvantage internet based remote monitoring, controlling, and reporting for a wide range of analog and digital applications.

#### Control Functions (Relay control only with option R)

Each of these control functions are based on a 4-20mA analog input and will include user-settable relay control settings along with a High and Low Alarm setting and Limit Timer. Each control function can control relay output. When the reading reaches (rises above or falls below) the Set Point the control relay is activated until the reading changes by the Differential amount.



## II. Installation

### Mounting Instructions

Select a mounting location that provides the operator easy access to the unit and a clear view of the controls through the cover of the controller. The location should be convenient to grounded electrical connections, and should be on a stable vertical surface.

### Electrical Wiring

The LIFTX has an internal regulated fused power supply that will operate off of 90 to 250 VAC at 47 to 63 Hz on the incoming wiring. Each output relay is individually protected with a replaceable fuse. Relay outputs will equal incoming line voltage.

 <b>CAUTION</b> 
1. There may be live circuits inside the controller even when the optional power switch is in the OFF position. Never open the front panel without first disconnecting power from the outlet. Prewired controllers are supplied with an 8 foot, 18 AWG power cord with USA style plug. A #1 Phillips driver is required to open the front panel.
2. Low voltage signal wires (mA, digital input, water meter, etc.) should never be run in conduit with high voltage (like 115VAC) wires.
3. Never attempt to land connections to the controller without first disconnecting power from the outlet.
4. Do not block access to disconnect power during mounting and installation.
5. The controller should be connected to its own isolated circuit breaker, and for best results, the ground should be a true earth ground, not shared. Any attempt to bypass the grounding will compromise the safety of users and property.
6. The electrical installation of the controller must be performed by trained personnel only and conform to all applicable National, State and Local codes.
7. Operation of this product in a manner not specified by the manufacturer may result in damage to equipment or persons.
8. Avoid mounting in locations that expose the controller to direct sunlight, vapors, vibration, liquid spills or extreme temperatures; less than 0°F (-17.8°C) or greater than 120°F (50°C). EMI(electromagnetic interference) from radio transmissions and electric motors can also cause damage or interference and should be avoided.

### NOTES:

1. Liquid tight fittings and some labeled signal leads are provided for all signal (low voltage) connections for both pre-wired and conduit units.
2. Units should be ordered with the appropriate option to provide powered relays designed for the incoming/outgoing power.

### Pre-Wired

Pre-wired units are supplied with a 16 AWG cable(s) with 3-wire grounded USA 115 volt plug for incoming power. If option R is selected 3-wire grounded receptacle cords for all control relay outputs also 16 AWG.

## Conduit

Conduit units are predrilled at the factory and supplied with conduit knockouts for easy hard wiring to supplied detachable connectors on the relay card(s) located in the lower section of the controller. Remove the screws of the lower panel for access.

### NOTES for option R:

1. **Do not drill holes in upper section of enclosure.**
2. All relays provide a N.O. and N.C. output.
3. The control function that activates each relay output is pre-configured at the factory based on the options selected. To change relay activation, see on page 13.
4. Refer to label inside lower panel cover for specific relay board configuration supplied.
5. Relays configured as “dry contact” should only have D.C. voltage ran through them. The GND connection point replaces the NEU when configured for dry contact. (Example: Use GND and N.O. for a normally open dry contact relay output.)



**WARNING:** If jumpers are not configured for dry contact, line voltage will be supplied.

## Motherboard Connections

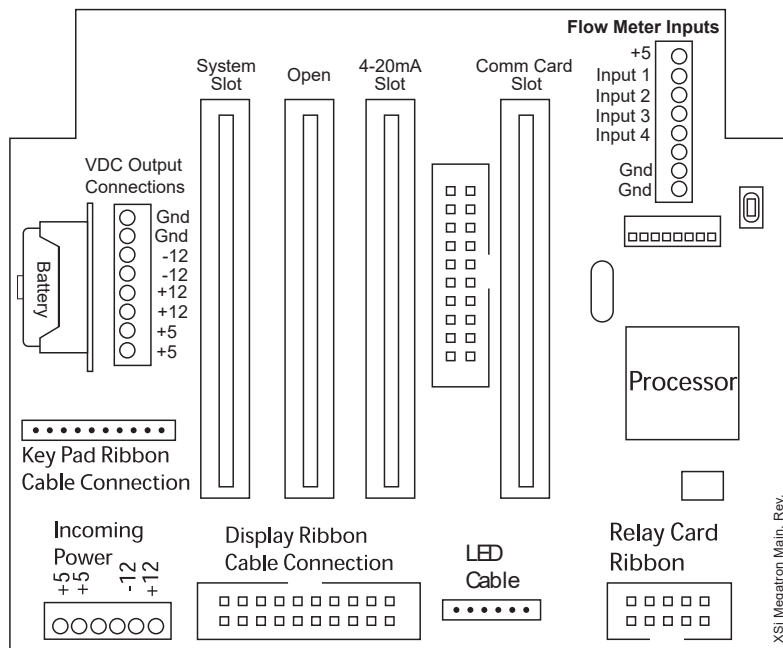

## System Card Connections

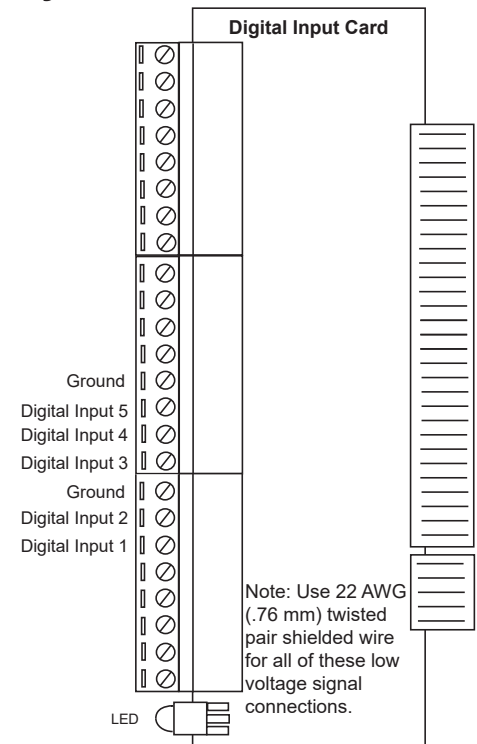

## 4-20mA Output Card Wiring

### A. Isolated Configuration

For isolated 4-20mA outputs an external power source for the loop must be supplied. JP4 and JP5 on the board must be jumpered for isolated with an external power source supplied to the external VDC input. The external power source must not exceed 24 volts DC.

### B. Non-isolated Configuration

For non-isolated 4-20mA outputs the controller will supply the power for the loop. JP4 and JP5 must be jumpered for non-isolated and no connections are made to the external VDC points.

**NOTE:** The power for the mA output loop is always provided by the controller with either isolated or non-isolated configuration.

## 4-20mA Input Card Wiring

The 4-20mA input card requires that the external device sending the 4-20mA input signal(s) supply the power for the loop. The external power source must not exceed 24 volts DC.

**Note:** All eight mA input cards and newer four input cards provide -12 VDC on the V- connections and +12 on the V+ when the card is not configured for isolated with an external VDC supplied. Older four input only cards and all four input & four output cards do not have -12 on the V- but have just a ground connection instead.

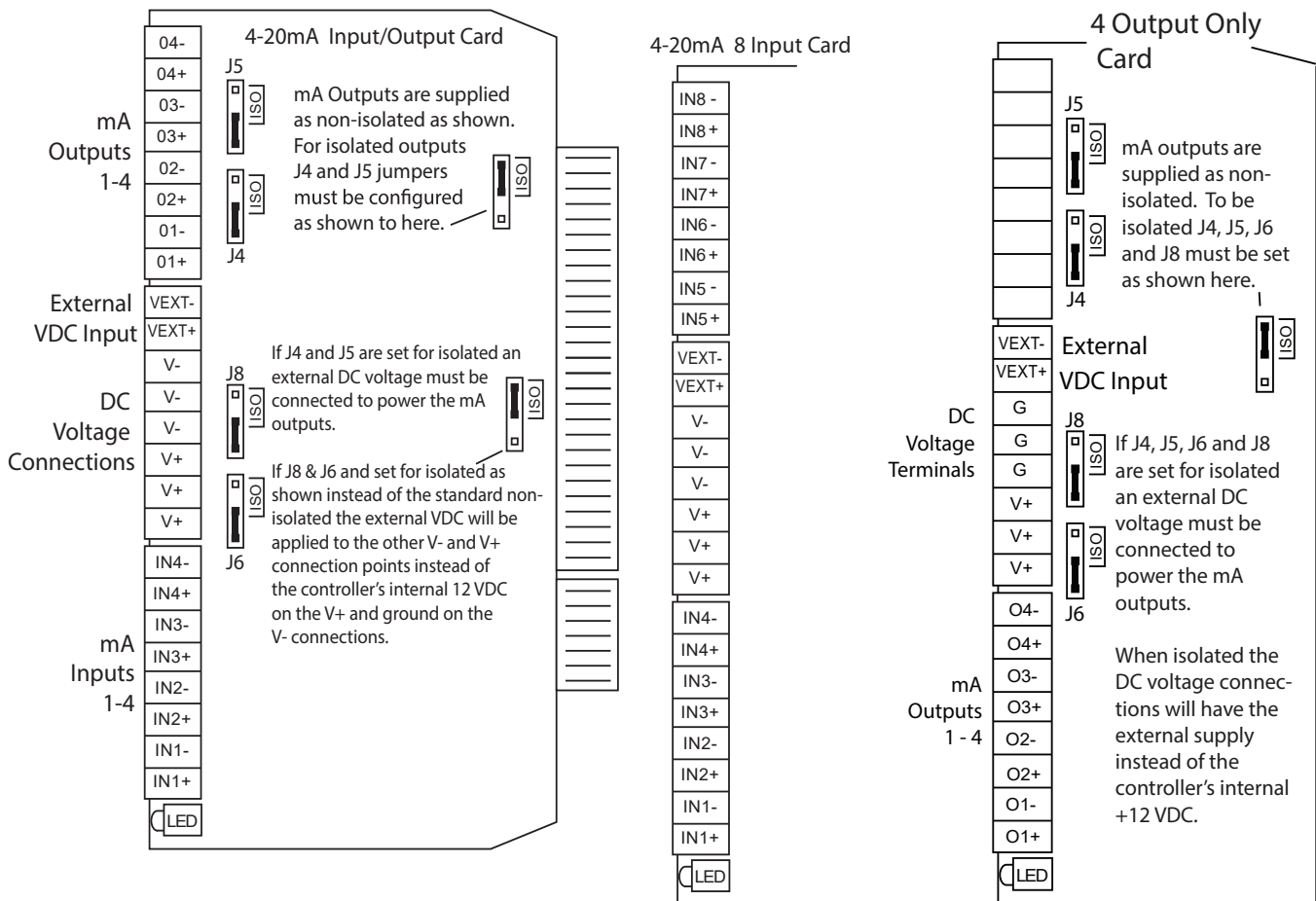

**Note:** Units with only mA outputs may be provided with a card that has the four outputs at the bottom of the card or the top of the card, depending on version used.

### III. Front Panel Description

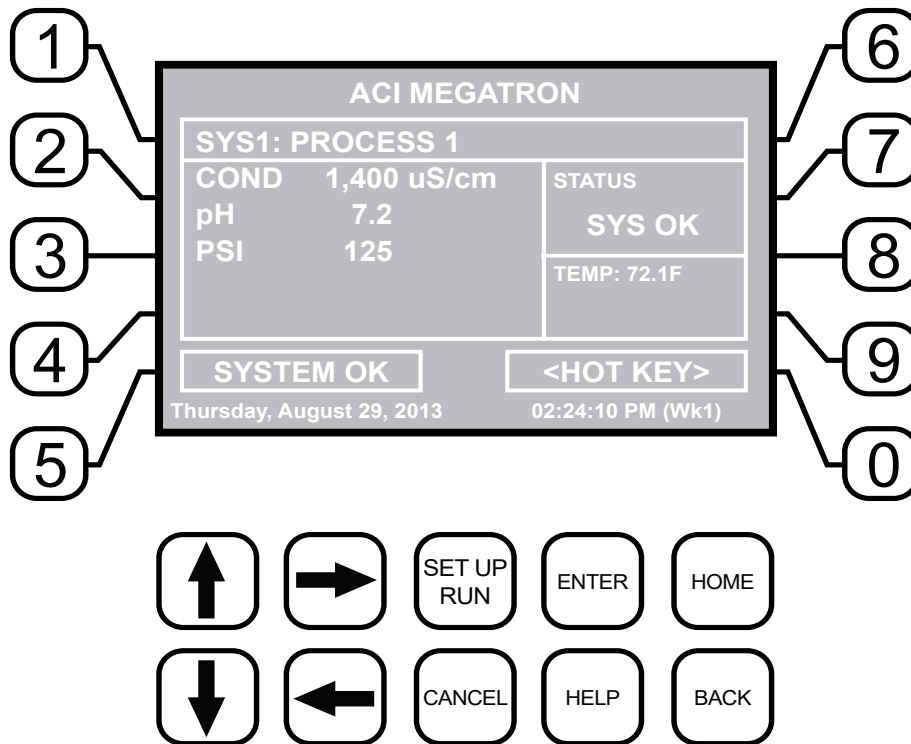

- NUMBER Keys- Used to enter new values in the SET UP mode and to access desired sub menus.
- UP/DOWN - Used to cycle through text options to find desired setting.
- LEFT/RIGHT - Used to cycle through text or setting options to find desired setting.
- SET UP/RUN - System initializes into RUN mode. Press this key to put the controller in SET UP Mode and see HOME menu page.
- ENTER - Used to log a changed value into program.
- HOME - Used to go back to the HOME menu page.
- CANCEL - Used to cancel a pop-up screen if no change is desired.
- HELP - Used to access help screens.
- BACK - Used to go back to last menu screen viewed or clear values keyed in that are not wanted.

The bottom right box in the RUN screen mode is a hot key that will take you directly to a particular menu screen. The hot key can be changed by navigating to the desired screen and pressing the HELP button. Follow the on-screen instructions to set the new hot key location.

## IV. System Operation Overview

### Operation

LIFTX controllers have two modes of operation, RUN and SET-UP.

**RUN** - This mode is for normal operation. In the RUN mode the display will show each system's parameters. If an alarm is present, the ALARM box will flash how many alarms are activated. No settings may be entered or changed in the RUN mode. Readings are updated every 6 seconds on the screen while in the RUN mode.

**SET-UP** - This mode is used to adjust settings and readings on the controller. To access the SET UP mode from the RUN screen, press the SETUP/RUN key.

## V. Menu Navigation

To access the menus press the Set Up / Run key on the front panel. This takes you to the Home menu. LIFTX controller's menus are easily navigated by pressing the associated number key next to a menu box on the screen. Once you have stepped through the sub menus to reach a point at which a value or selection is made a Pop-up window will appear prompting you to enter a desired value or selection.

**NOTE:** When entering new numeric values, enter all available digits (characters). this unit does not have relay outputs

### 1. Home Menu

>HOME SETUP<	
SETPOINTS	DATE/TIME
CALIBRATION	CONFIGURE
	HISTORY
CUSTOMIZE	TOTALIZERS
ALARMS	RELAYS

From the **HOME** menu select the desired menu. The menu name explains what parameters can be programmed in the menu.

<b>SET POINTS -</b>	Setting control set points for mA inputs and digital input alarming.
<b>CALIBRATION -</b>	Calibrating mA signals if present.
<b>CUSTOMIZE -</b>	Giving the controller, system, mA inputs and all relays a user defined name.
<b>ALARMS -</b>	View current alarms.
<b>DAY/TIME -</b>	Menu for setting date and time.
<b>CONFIGURE -</b>	Menus for configuring passwords, relay activations, setting history interval, contrast.
<b>HISTORY -</b>	Allows for view history on board in a graph form.
<b>TOTALIZERS -</b>	Menu for configuring flow meter totalizing if present.
<b>RELAYS -</b>	Menu for resetting accumulated "ON" times and manual relay activation.



## 2. Set Points

The same basic format is used for defining each available analog mA control parameters.

```
>SYSTEM 1 SET POINTS<
                                     mA OUT
                                     mA IN
                                AUX INPUTS
```

**SET POINTS** - For setting the relay set points for the available analog readings.

**NOTE:** In the Setpoint pop-up screen the direction (Rising or Falling) of the setpoint can also be set. Rising setpoints will activate the control relay when the particular reading rises above the setpoint and will stay activated until the reading comes down by the amount of the differential. If set for Falling the relay is activated when the probe reading falls below the setpoint and stays on until the probe reading comes back up by the amount of the differential.

### 2.1 Set Point Options

```
>mA INPUT 1 SETPOINT<
SET POINT          DISABLER
DIFFERENTIAL
HIGH ALARM
LOW ALARM
LIMIT TIME
```

**SET POINT** - What reading turns the relay on  
**DIFFERENTIAL** - Amount reading changes by before the relay is turned off  
**HIGH ALARM** - What reading generates a High alarm.  
**LOW ALARM** - What reading generates a Low alarm.  
**LIMIT TIMER** - What amount of continuous control will generate a time alarm notice. The relay is locked-out by this alarm.  
**DISABLER** - One of the digital inputs can be selected to prevent alarming.

**Note:** Each alarm value can also be set-up to be displayed or not on the front screen as well as remotely notified or not if connected to the Web Advantage server.

### 2.2 Aux Inputs

Auxiliary inputs are the generic digital input status indicators from external dry contacts. From these menus the user can set if they want each of the status alarms Displayed, Remote Notification, both or none.

```
>SYSTEM 1 DIGITAL INPUTS ALARM<
ALARM NOTIFICATION    DIGITAL 1
                      DIGITAL 2
DIGITAL 1 = DISPLAY   DIGITAL 3
                      DIGITAL 4
                      DIGITAL 5
```

**NOTE:** Digital inputs can have the direction selected between OPEN or CLOSED as the alarm polarity. If set for CLOSED, the input will be in alarm when it sees a closed contact.

## 2.3 4-20mA Out

Units with a 4-20mA output option will have a menu for setting up the 4-20mA output. The 4mA and 20mA values can be defined by giving the output proportioning capability. i.e. 4mA = a pH of 6.0 and 20mA = a pH of 8.0.

```
>OUT 1 SETUP<
SIGNAL SOURCE
4mA VALUE
20mA VALUE
```

**SIGNAL SOURCE** - Select which mA reading the mA will use as its reading source.

**4 mA VALUE** - What the 4mA signal equals

**20mA VALUE** - What the 20mA signal equals on the assigned signal sources scale.

## 3. 4-20mA Output Calibration

```
>CURRENT LOOP CALIBRATION<
OUTPUT 1
OUTPUT 2
```

4-20mA outputs can be calibrated to ensure that the output generated by the controller and received by the external device match. With a volt meter connected across the out and return wires (see page 7) of the 4-20mA output channel to be calibrated go into the output's Low or High calibration.

```
>mA OUTPUT 1 CALIBRATION<
HIGH 4030
LOW 800
```

The number displayed in the Calibration dialog box can range from 0-4095 with 800 equal to 0 mA output and 4030 equal to 20 mA. This number range of 0-4095 is the raw digital to analog (D/A) values and is strictly used for a reference. The D/A numbers you get will vary based on your installation conditions.

```
>mA OUTPUT 1 CALIBRATION<
OUTPUT 1 CAL HIGH
4000
Use Up/Down arrows to change
Use Enter to save value
```

While in the High or Low calibration pop-up screen use the up and down arrows to change the output value being read with the volt meter. Adjust the High value for the 20-mA reading and the Low value for the 4 mA value.

### 3.1 4-20mA Input Calibration

4-20mA inputs can be calibrated to ensure that the input seen by the controller from the external device match. It also allows for setting the 4-20mA input into a number range that relates to the value being read.

```
>CURRENT LOOP CALIBRATION<
INPUT 1
INPUT 2
```

Select the Input to be calibrated

>mA INPUT 1 CALIBRATION<	
20mA	5500
4mA	1100
MAX	200
LOW	0
OFFSET	FACTORY DEF.

Firmware version KA.16.03 and up have logic that suspends any control logic if the mA received is 50% below the stored 4mA value. A # will be placed in the RUN screen for any mA value in this invalid state.

The **20mA** and **4mA** values are where the controller's raw analog to digital value is adjusted to match a 20mA (full scale) and 4mA (bottom of scale) signal from the external device inputting the 4-20mA input. The external device must be connected to the controller and showing either full scale or bottom of scale when calibrating each. The number shown along with either the 20mA or 4mA while calibrating is the raw A/D value and is only a reference. A 20mA input should be around 5500 and 4mA around 1100. If the A/D numbers are not in this range check input device.

The **MAX** and **LOW** calibration inputs are for telling the controller what to display for a 20mA input and a 4mA input. For example, if the input is a drum level sensor monitoring a 55-gallon drum the value for MAX should be 55 and LOW should be 0. The controller then displays a number automatically ranging between 55 and 0 based on the input value. The units of measure (gallons for example) is set in the Customize menu from the Home page.

**OFFSET** - Changes the current displayed value of the 4-20mA input reading to allow for a manual 1pt calibration of the displayed value.

**FACTORY DEFAULT** - If the 20mA or 4mA calibration has been incorrectly set (not at 4 or 20) this will reset the settings back to a factory value for 4 and 20.

#### 4. Customize

This menu allows the user to define the on-screen name of the unit plus the name of each system and relay. The user can also setup the Notepad for each system and 4-20mA Input's name and unit of measurement.

>CUSTOMIZE<	
UNIT NAMES	
RELAY NAMES	NOTEPAD
SYSTEM 1 NAME	mA IN
	RUN SCREEN

**RUN SCREEN** - Allows user to select which mA inputs and/or flow meter inputs are shown on the screen in RUN mode.

**NOTE:** When entering values for custom names use the numerical keys for numbers and the up / down arrows to scroll through all the characters of a key

board. Press the right arrow to advance the cursor after setting a desired value. Press the Help button to place the last entered character into the new cursor space to speed up the process. The Help button will also jump advance through the characters.

## 4.1 Notepad

The Notepad function allows the user to set up a customized manually entered data field for each system with ten notepad items. The NOTEPAD is ideal for setting up and storing into the controller's history the items typically tested for reporting a service call. The Notepad items come with no names but when an individual note is selected a menu for setting it appears.

```
>NOTEPAD SYS 1 NOTE 1<
NAME
NUMBER
UNITS
ALARMS
```

**NAME** - Pick from a list of defined names or customize your own.

**NUMBER** - Set the number range.

**UNITS** - Set the units of measurement.

**ALARMS** - Set Hi/Low alarm points and how frequently a new value is expected to be manually enter via the History menu.

## 4.2 mA Inputs

```
>mA INPUT 1 CUSTOMIZE<
NAME
UNITS
NUMBER
```

**NAME** - Name the input.

**UNITS** - Set the units of measurement.

**NUMBER** - Set the number range.

## 4.3 Run Screen

This lets you customize various aspects of the RUN screen.

```
>RUN SCREEN<
MAIN SCREEN
SCREENS SHOWN
CYCLE TIME
```

**MAIN SCREEN** - Customize what is displayed on the RUN screen.

**SCREENS SHOWN** - Pick if the mA input & Aux Flow screens are scrolled.

**CYCLE TIME** - The amount of time between screen scrolls.

## 5. Alarms

```
>ALARMS<
SYS 1 ALARMS
```

**ALARMS** - Shows any current alarms.

## 6. Date and Time Set Up

```
>SET DATE AND TIMES<
SET DATE
SET TIME
SET DAY
SET WEEK
Friday May 14, 2005 03:04:56
```

**DATE AND TIME** - For setting the date, time, day and week on the controller.

## 7. Configure

Provides access to menus to set-up passwords, relay activation, temp scale, display contrast, flow switch, inputs, history time stamps, factory set-up and system information.

>CONFIGURE<	
PASSWORD	CONTRAST
RELAYS	
	NETWORK
HISTORY	SYS INFO
	FACTORY

**CONTRAST** - This screen allows for adjusting the display contrast.

**FACTORY** - A factory only menu

**TEMP SCALE** - Set Celsius or Fahrenheit

**HISTORY** - Sets the history time stamp interval.

**SYS INFO** - Tells unit software specifics.

### 7.1 Password

>CONFIGURE PASSWORDS<	
ADMIN PASSWORD	
USER PASSWORD	
USER SET UP	

**ADMIN PASSWORD** - The administrator password gives access to all menus except factory set up.

**USER PASSWORD** - The user password allows the user to access HOME menus that are made available in USER SET UP.

### 7.2 Relays (if supplied)

>RELAY 1 SETUP<	
MAIN ACTION	DISABLE 1
ACTIVATOR 2	DISABLE 2
ACTIVATOR 3	DISABLE 3
ACTIVATOR 4	DISABLE 4
DELAY	DAILY MAX

**CONFIGURE RELAYS** - This menu lets you choose a **Main Action** or function (mA input setpoint, etc...) to activates a relay.

A pop-up screen appears with a list of all available activation functions to arrow through.

Additional relay logic is available with up to 3 additional **Activators** and up to 4 **Disablers** allowing multiple functions to activate the same relay and multiple functions to prevent the relay from coming on. There is also a Daily Max amount of time that a relay can be on. If a relay is on for the max amount, it does not let the relay come on anymore that day. (A 24-hour clock is used for the day with midnight being the start of the day). The Delay setting is the amount of time a control function must come on before the relay will react and activate. This is to prevent a relay from chattering on/off if a reading is bouncing around the set point or alarm.

### 7.3 History

This menu is used to set the history "time stamp" interval, the water meter daily history starting hour, the alarm delay period and the USB history save format.

>CONFIGURE HISTORY<	
INTERVAL	
W/M HOUR	
ALARM DELAY	
SAVE FORMAT	

**INTERVAL** - The amount of time between each history time stamp for probe readings.

**W/M HOUR** - The time of day that the daily water meter history cycle is to start.

**ALARM DELAY** - The amount of time an alarm has to be on before it is recognized as an alarm.

**SAVE FORMAT** - The USB history save format.

## 7.4 Contrast

This menu is used to adjust the contrast of the display.

## 7.5 Network

The Network menu is used when a controller is being remotely communicated with either a local network connection or over the internet on the Web Advantage server.

```
>NETWORK<
IP Addr: 192.168.001.006
Subnet: 255.255.255.000
Gateway: 192.168.001.253
DNS: 192.168.1.238
ACI Srvr: connect.webadvantage.online:443
MAC: E4.38.F2.00.01.3C
DHCP: ENABLE

DIAGNOSTICS
SETTINGS

WIFI
DHCP
RESET
```

**NETWORK** - This menu is used for setting up the remote WebAdvantage communications and is covered in a separate manual.

<http://www.advantagecontrols.com/downloads/pdf/M-WebAdvantage.pdf>

**NOTE:** The Network card must be RESET after making any changes to Network setting in order to save changes and reset communications.

**WIFI / DHCP** - Enable or disable if available.

**SETTINGS** - This menu is used to configure a variety of extended network options.

```
>CONFIGURE NETWORK<
IP ADDRESS          WIFI NETWORK
IP MASK             HTTP REMOTE
GATEWAY             FTP
SERVER
HTTP LOCAL
```

**WIFI NETWORK** - This menu is used for choosing the local wifi network and setting the password. This is covered more in a separate manual.

[https://www.advantagecontrols.com/downloads/quicksteps/QS-MegaTronXS-MT\\_H\\_WiFi.pdf](https://www.advantagecontrols.com/downloads/quicksteps/QS-MegaTronXS-MT_H_WiFi.pdf)

**NOTE:** Some choices may not be available if DHCP or WI-FI are disabled in previous NETWORK menu.

## 7.8 System Information

System information will identify the version of firmware installed in the controller along with the controller's serial number.

## 8. History

The onboard history allows for viewing the history of the mA readings, relay activations, key-pad activity, calibrations, flow meter hourly and daily logs and alarms for each system present. It is also where Notepad data is entered and reviewed. An initial overview page is displayed showing your current sample interval, the calculated number of days the unit can keep probe history for before losing the oldest. The number of sensor samples and relay/alarm events and Notepad entries currently stored is also displayed.

```
>HOME REVIEW<
SYSTEM 1      Sample Time: 5 MIN
              (Length 164.62 days)
              Sensor Samples
              882
              Relay/Alarm Events
              323
              Notepad Entries
```

**NOTE:** The history can be reset by going to the configure menu and entering a different sample interval. After the new sample interval has been set the onboard history is reset.

## 8.1 Viewing History

```
>HISTORY<
RELAY LOGS          WATER METER
ALARM LOGS
SENSOR HISTORY
EVENT LOG
NOTEPAD
```

**RELAY LOGS** - Relay activations displayed in a log form. Arrow up to advance through the log.  
**ALARM LOG** - Alarm activations in log form.  
**SENSOR HISTORY** - For selecting the parameters and viewing of a given probe reading's history in log or graph form.  
**EVENT LOG** - Displays various activities.

## 8.2 Notepad Entries

```
>NOTEPAD: SYS 1 NOTE 1<
ENTER VALUE      Total Hardness
LOG              8 Entries
GRAPH
                517.2 Hrs to Alarm
```

The Notepad section under History is where the user goes to enter new values for the customized notepad items. Each individual notepad item's manually entered entries are stored in the unit's history and can be reviewed in log or graph form after 4 or more values have been entered.

## 9. Option W Totalizers

LIFTX controllers with "W" option may have 1 to 4 auxiliary flowmeter inputs. These additional inputs are for tracking various flow meter devices (additional water meters or flowmeters in a metering pump's discharge tubing). They can also be linked to a system's water meter input for additional tracking and alarm capabilities including: bleed flow/no flow, exceeding too much flow in a 12- or 24-hour period. Units with Auxiliary Flow meter inputs have a Home menu selection for Totalizers. The Totalizer menu has selections for each of the System Water Meters plus one named Aux Meters.

```
>TOTALIZERS<
SYS 1 WATER METER 1
SYS 1 WATER METER 2
                AUX METERS
```

Select the system water meter to set-up or go to Aux Meters to set-up the auxiliary flow meters.

### 9.1 Aux Meters

A unit may have 1 to 4 Aux Meters. These additional inputs are for tracking various flow meter devices like Advantage Controls' FloTracker in a metering pump's discharge tubing. They can also be linked to a system's water meter input for additional tracking and alarm capabilities.

```
>FLOW METER<
FM01: AUX METER A
FM02: AUX METER B
FM03: AUX METER C
FM04: AUX METER D
```

Select the Aux Flow Meter to set-up or review.

## 9.2 Aux Meter Review

A review screen of the current settings is provided with a selection for the Tracking method and the Settings.

>FLOW METER 1<	
TOTAL VALUE:	9966.0 ML
FLOW RATE:	0.0 ML/MIN
CONTACT VALUE:	0.33 ML/CONTACT
LAST RESET ON:	08/25/2006
VOLUME ALARM:	1000 LITERS (24 HOURS)
ALARM NOTIFY:	(DISPLAY)
VOLUME:	0.0 LITERS
VERIFY ALARM:	100 SEC (DISPLAY)
RELAY LINK:	SYS1 TIMER3
<b>SETTINGS</b>	<b>TRACKING</b>

**SETTINGS** - Access the various settings for the flow meter.

**TRACKING** - Provides a pop-up screen to select either FloTracker or Rate and Volume tracking.

**NOTE:** Select FloTracker if the aux meter is a FloTracker. Select Rate and Volume if tracking a water meter or other batch flow device.

## 9.3 Aux Meter Settings

>FLOW METER 1 SETUP<	
<b>PULSE VALUE</b>	<b>VOLUME ALARM</b>
<b>UNITS</b>	<b>RESET VOLUME</b>
<b>RESET TOTAL</b>	
<b>VERIFY ALARM</b>	
<b>RELAY LINK</b>	<b>METER LINK</b>

**PULSE VALUE** - Defines the numerical value for a contact, i.e. 225.

**UNITS** - Defines the units of measure for a contact, i.e. Pulses / Ounce.

**RESET TOTAL** - Resets the totalized count of the meter.

**VERIFY ALARM** - If a flow meter is linked to a control relay the controller will give an alarm if it does not receive a contact or pulse from the aux meter within the amount of time defined or if it gets a contact when the relay is not on.

**RELAY LINK** - The relay link informs the particular aux meter input is relevant to the control function that the selected relay is being driven by. For example, if the aux flow meter is a metering pump's FloTracker then it should be linked to the relay that is driven by the feed timer that pump will be controlled by. If the aux meter is going to be linked to a water meter in a bleed of line, then it should be linked to the relay that is controlling the bleed off valve.

**VOLUME ALARM** - If FloTracker has been selected as the Tracking method, an alarm will occur when the defined VOLUME USED has passed through the flow device.

**NOTE:** If Rate and Volume tracking has been selected an alarm will occur if the defined MAX VOLUME amount is measured within the defined TIME CYCLE which can be a 12-or-24-hour period.

**RESET VOLUME** - Resets the Volume Alarm totalizer.

**METER LINK** - This selection only shows if the tracking method is Rate and Volume and tells the auxiliary flowmeter input to get its signals from one of the system water meters already wired to the controller's water meter inputs. If this is selected no wiring to the auxiliary input is required and the PULSE VALUE and UNITS settings are auto populated from the particular water meter's settings.



## 10. Relays (if supplied)

```
>RELAYS<
STATUS
RESET
FORCE
```

**NOTE:** This unit does not have relay outputs.

**STATUS** - Allows for viewing accumulated relay ON times, temporary forcing relays ON or OFF or seeing which relay is on.

**RESET** - Allows the accumulated run time of a particular relay to be reset to zero.

**FORCE** - Allows a relay to be manually forced ON for a single event from 0-99 minutes. When the event is over the relay goes back to its normal automatic control.

```
>RELAY STATUS<
R01: ON          006:30:30
SYS1 COND BLEED
R02: OFF         008:56:35
SYS1 pH
R03: OFF-T       011:00:10
SYS1 TIMER1 INH
R04: OFF         007:00:00
SYS1 TIMER2 BIO1
R05: OFF         008:10:30
SYS1 TIMER3 BIO2
```

In the STATUS view the accumulated ON time is shown along with the main activator, custom name and current status:

ON = Relay on by relay activators

OFF = Relay off by normal logic

OFF-T = Relay off for daily max

OFF-D = Relay off for relay disabler

ON-A = Relay activated by activator other than main action

H-ON = Relay manually forced on

H-OFF = Relay manually forced off

## VI. WebAdvantage Setup

### WebAdvantage Connection - SETUP CHECKLIST

- Do you have a WebAdv3 USER ID and password? \_\_\_\_\_ **Yes**, if 'No' proceed to page 18.
- Has your account admin added the device and linked it to your USER ID? \_\_\_\_\_ **Yes**, if 'No' proceed to page 19.

*Congratulations!* You are now ready to go online with WebAdvantage. <https://webadvantage.online/>

**Complete  
WebAdvantage  
Manual**



# USER ID Setup

## Setting Up a USER ID

Before you can view a device, a **USER ID** must be setup. NOTE: If you already have a USER ID and are just adding a new device, skip to step 4.

**Step 1:** Visit <https://webadvantage.online> or access the registration form with the QR code below.



**Step 2:** Choose **Create Account?** at the bottom of the login screen.

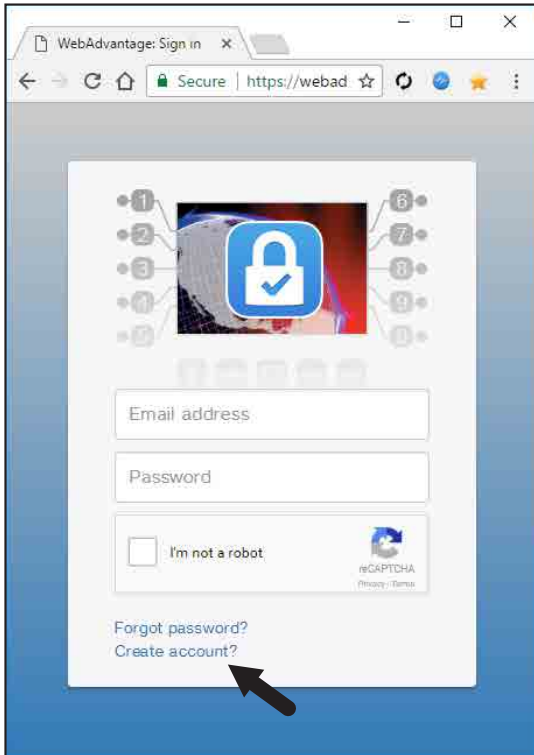

**Step 3:** After completing form click **SAVE** to create ID.

**NOTE:** The email address you add will be your **USER ID**.

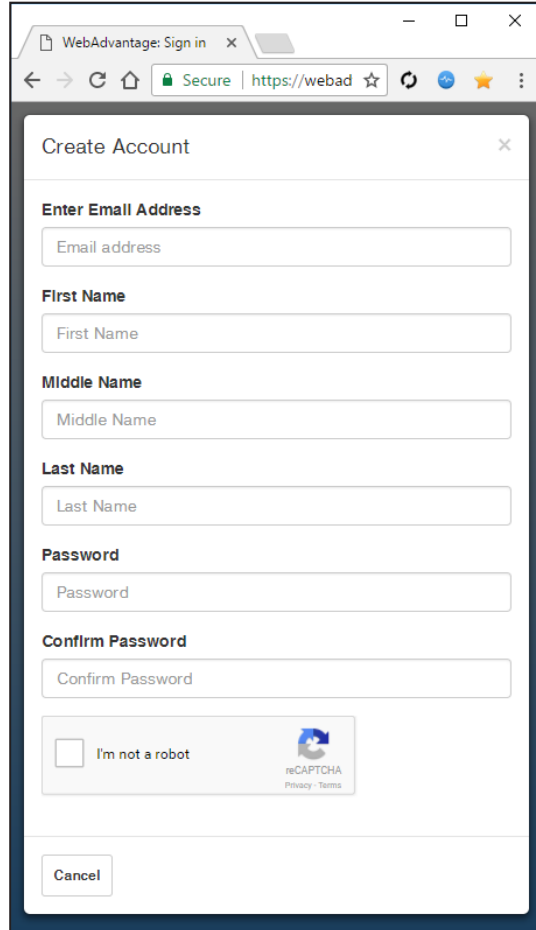

**Step 4: Important!** Contact our WebAdv3 dept with your USER ID (email), the device's serial number and your phone number.

<b>USER ID (email)</b>	
<b>Device Serial #</b>	
<b>Phone:</b>	

**Fax:** 918-686-6212

**Phone:** 918-686-6211

**Email:** [support@advantagecontrols.com](mailto:support@advantagecontrols.com)

**NOTE:** Please allow **24 hours** for processing.

# Admins Only: Add Device and Assign USER ID

## Setting Up / Accessing a Device

**NOTE: USER ID and Company Access Permissions are required before you can access a device.** For creating a USER ID see the Setting Up a USER ID steps on page 17.

Company Access Permissions: If you are not a part of a company already registered with WebAdvantage, please contact your company's WebAdv account manager for device access.

**Step 1:** Access the WebAdvantage page at <https://webadvantage.online>.

**NOTE:** Only company administrators can add, edit, remove or modify devices, user accounts, history reports. User account permissions only allow for viewing of devices.

**Step 2:** Choose **Administration** at top of page.

**Step 3:** Then choose **Manage Devices**.

**Step 4:** Enter the device's **Name** and **Serial Number**. The remaining fields are optional. Click **SAVE** to submit.

**NOTE:** Please allow up to 24 hrs for processing before controller shows in device list.

WebAdvantage support can be reached at 918-686-6211 or via email at [support@advantagecontrols.com](mailto:support@advantagecontrols.com).

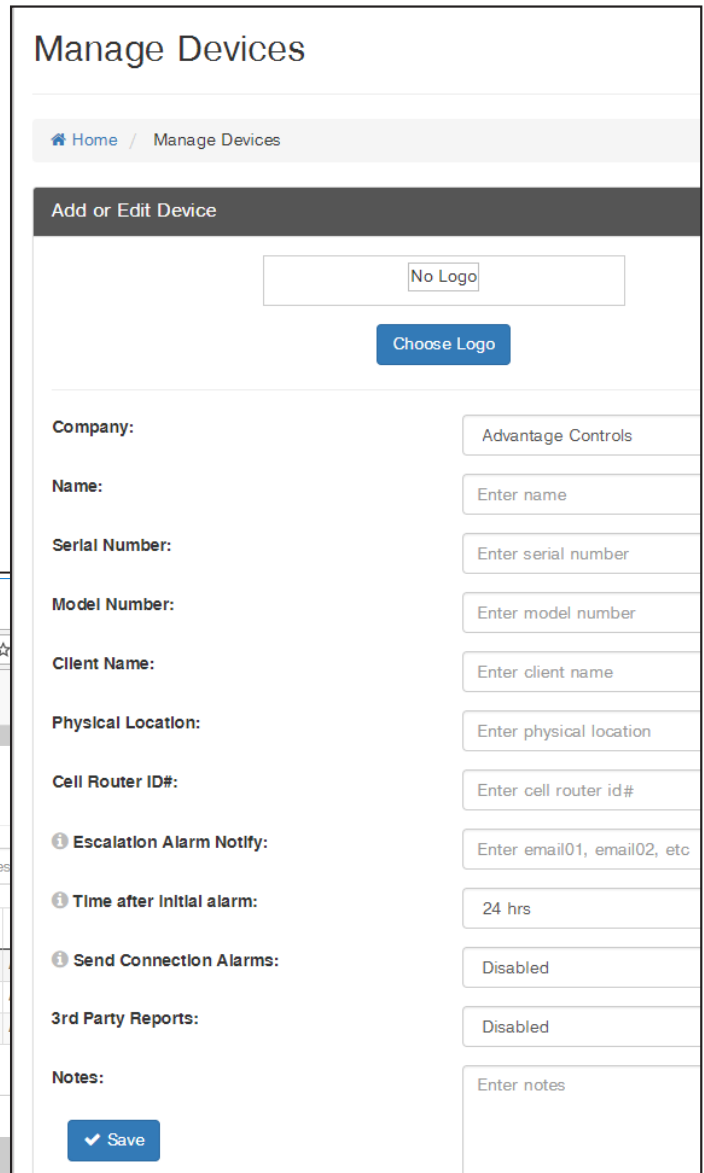
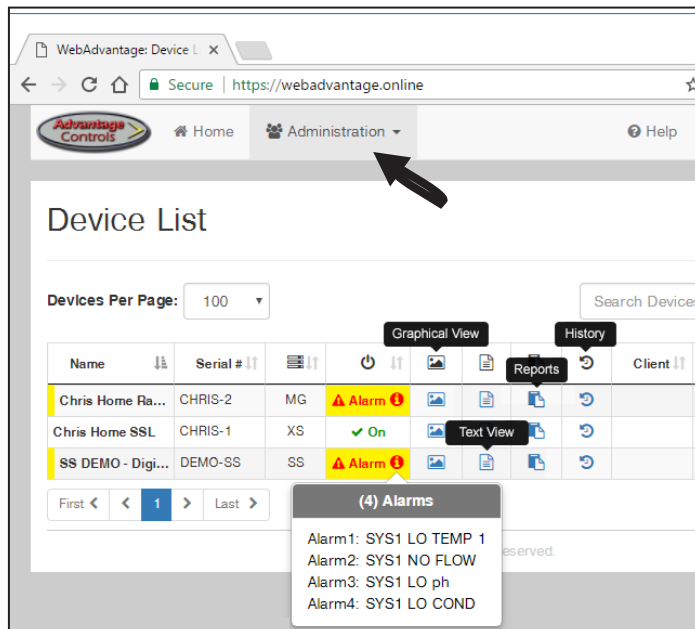

## LIFTX Monitor - USB Functions

The LIFTX is capable of transferring information using a FAT formatted USB drive. The LIFTX has three main USB functions as detailed in the following sections:

1. Exporting log data
2. Upgrading firmware
3. Cloning user settings for other units

### Getting Started

With the controller powered up, plug the USB drive into the LIFTX USB port. The USB DRIVE DETECTED pop-up window will appear.

#### Notes:

- You may be required to enter a password.
- USB drives must be FAT formatted.
- Not all customized names will be saved.

### Exporting Log Data

History from an LIFTX monitor can be saved to a USB drive in one of two file formats: WebAdvantage or generic comma separated (default).

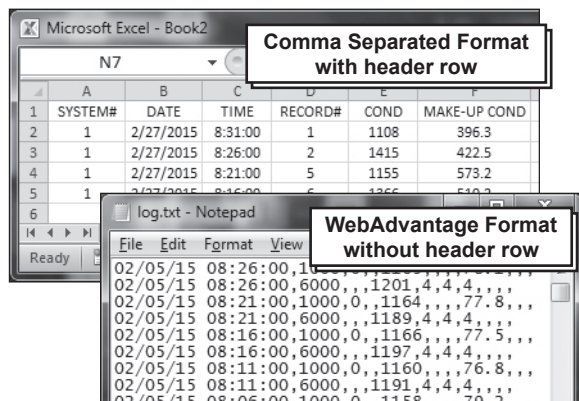

Sample Log Data "log.txt" files

To change formats, see Step 2.

### Step 1:

To transfer the contents of the LIFTX history logs to the USB drive, select → **History** → **USB** by using the Arrow buttons. Then press ENTER.

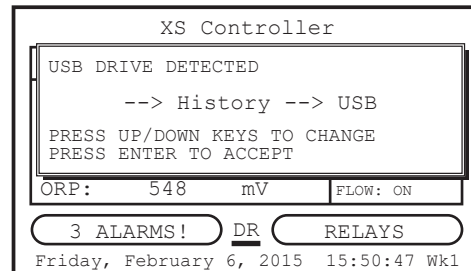

Note: Status will be displayed on the screen to show the percent completed of each log record type. Once the log is completely stored, the pop-up window will close. If only a small amount of data is available the screen may disappear quickly. The USB drive will now contain a file name: example "LOG\_AB-1234.TXT". The AB-1234 will be the unit's serial number.

### Step 2: Changing the File Format

This is the **RUN** Screen.

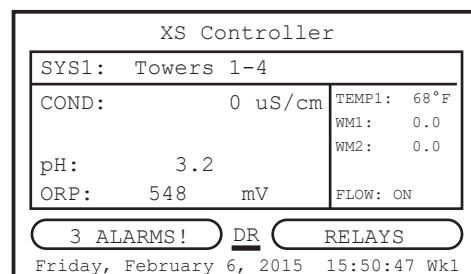

### Step 3:

Push the **SET UP RUN** button to get this screen. From here push **CONFIGURE** (Button 7) to go to the next screen.

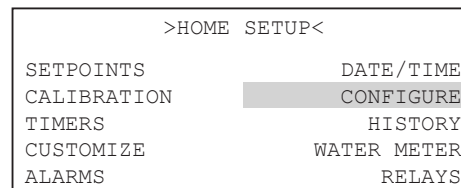

## LIFTX Monitor - USB Functions

**Step 4:**

This is the Configure Screen. From here push **HISTORY** (Button 4) to go to the next screen.

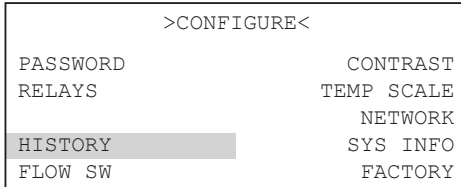

**Step 5:**

This is the Configure History Screen. From here push **SAVE FORMAT** (Button 4) to go to the next screen.

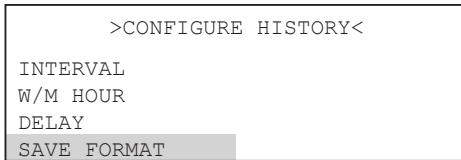

**Step 6:**

Set the value of the **HISTORY SAVE FORMAT** by using the arrow keys. Then press **ENTER** to confirm and go to the previous screen.

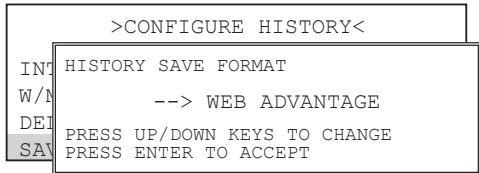

**Note:** WebAdvantage format is required for uploading history to WebAdvantage for cloud storage and graphing. Change to Comma Separated format if using a database software like Excel.

Press **SET UP RUN** to return to the RUN screen.

**Step 7:**

Remove USB drive and re-insert to initiate the USB DRIVE DETECTED pop-up window. Repeat Step 1 from section *Exporting Log Data*.

### Uploading data to WebAdvantage

If the controller does not have a communications card you can purchase WEBADV-XSCLOUD storage of your unit's history. This one-time fee per controller allows the LIFTX history to be stored on WebAdvantage for using custom graphing and multiple user internet access. Contact Advantage Controls or [support@advantagecontrols.com](mailto:support@advantagecontrols.com) with your unit's serial number to learn more.

After a LIFTX is set-up for cloud storage, follow these steps:

1. Login to the secure web server: <https://webadvantage.online>
2. Locate the controller you have data for and click **Reports**
3. Click **History Upload** on the left
4. Click **Choose File** and select the file you exported.
5. Click **Submit** and the data will upload
6. You will now be able to view reports and history data once completed.

### Upgrading Firmware

To upgrade the firmware on your LIFTX, copy the updated software version to a USB drive. The file name should be "firmware.bin" With the controller powered up, plug the USB drive into the LIFTX USB port. The USB DRIVE DETECTED pop-up window will appear. If a password is in the unit, the USB will ask for it.

Select **--> Update Firmware** by using the Arrow buttons. Then press **ENTER**.

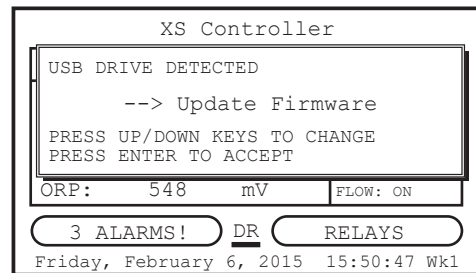

**Warning:** Do not remove power or USB during updating. It may take a few minutes to complete. Once the first update is complete, power off and remove USB. Wait 20-30 seconds to power back on and reinstall the USB after the RUN screen appears and load the firmware a second time.

## LIFTX Monitor - USB Functions

After second update is complete, power down and remove USB. Power back on (after 20 seconds) and go to the Configure menu.

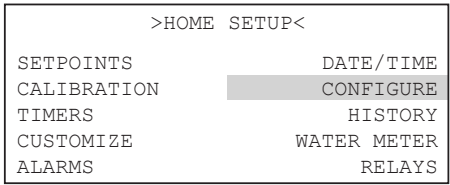

From here push **SYS INFO** (Button 9) and confirm that the unit now has the new version and that the **CARD** version is also current (consult factory for current).

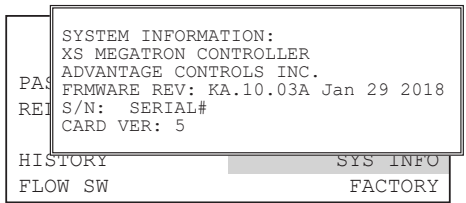

**Warning:** If the card revision has not updated to the newer version, the sensor function will not work correctly. A few power cycles may be needed to get the system card updated. The mA input and communications card (if present) may need to be removed with the power off and a power cycle performed. Once the system card version is updated, power back down and reinstall the mA and communications cards.

### Cloning User Settings for other Units

The LIFTX has the ability to copy the User Settings from one unit to another. This process is referred to as cloning.

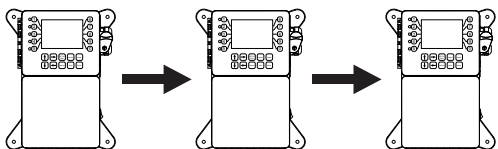

#### Step 1:

With the controller powered up, plug the USB drive into the LIFTX USB port. The USB DRIVE DETECTED

pop-up window will appear. Select → **Config** → **USB** (Config to USB) by using the Arrow buttons. Then press ENTER.

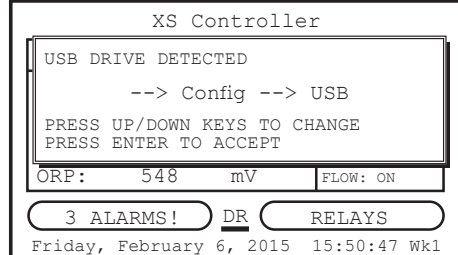

The User settings will be saved to the USB drive under the file name "CONFIG.BIN". The pop-up window will close when the copy is completed.

#### Step 2:

Plug the USB drive into the LIFTX that you would like to copy the User Settings to. The USB DRIVE DETECTED pop-up window will appear.

Select → **USB** → **Config** (USB to Config) by using the Arrow buttons. Then press ENTER.



**CAUTION:** Do not choose → Config → USB again or you will save over your USB contained CONFIG.BIN file.

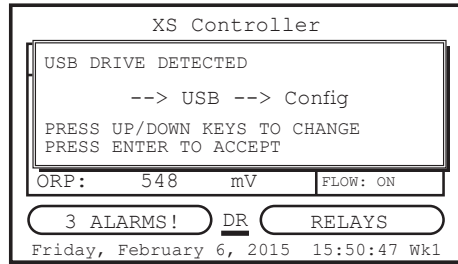

The User Data will be loaded into the LIFTX from the USB drive. Once the pop-up window closes, cloning has been completed.

#### Notes:

- Not all customized names will be cloned.
- If you have trouble reading clone files, insure that the LIFTX you are cloning has current firmware.

# VIII. Additional mA Sensor Wiring

## mA Input Sensor Wiring

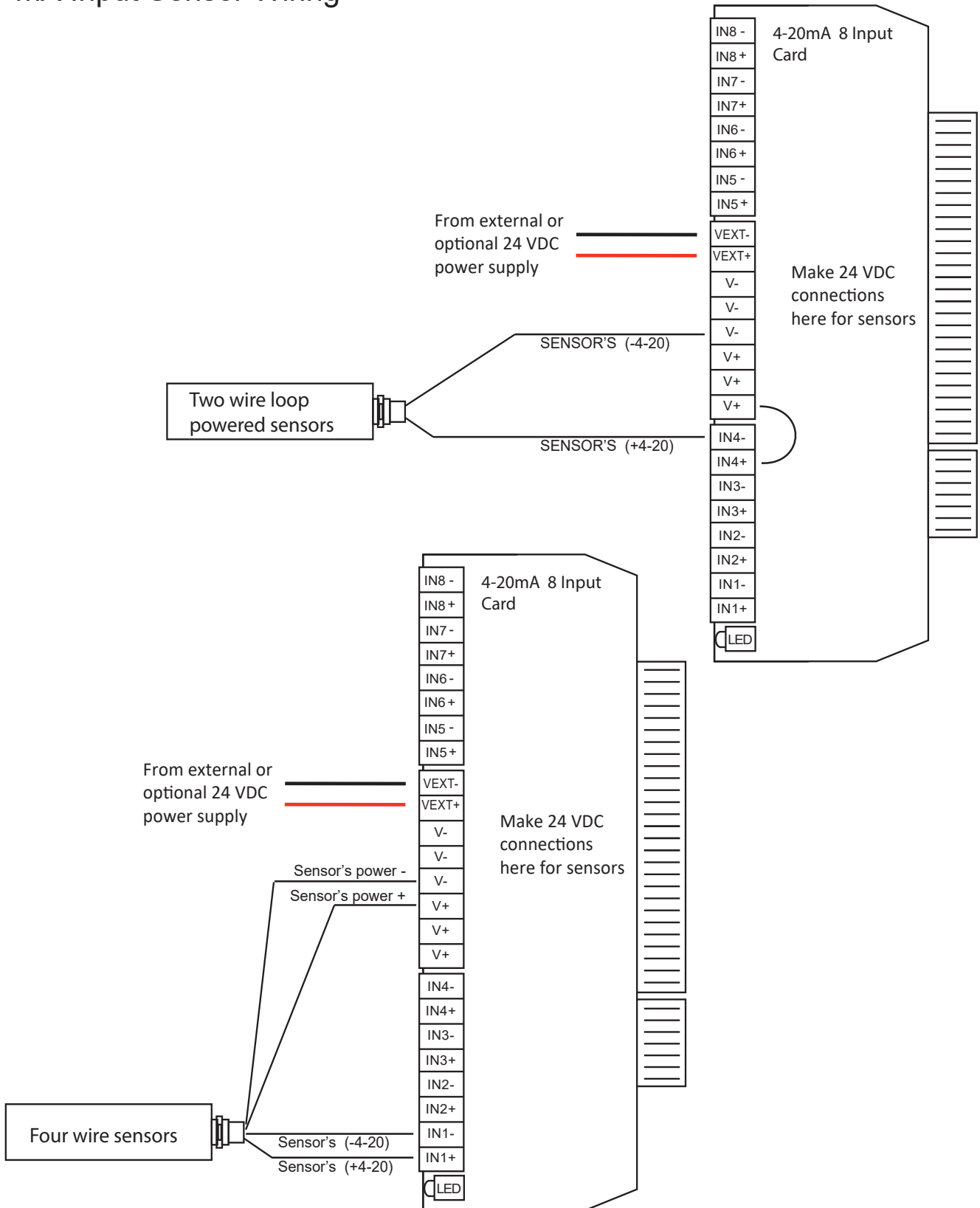

## IX. Troubleshooting

The LIFTX is designed for many years of trouble-free operation. Should a problem occur, refer to the following chart to help identify the problem. If replacement is required, follow the procedures listed in the Warranty and Factory Service portion of this manual.

SYMPTOM	POSSIBLE CAUSE	SOLUTION
False mA reading	Bad or dirty electrode Out of calibration	Clean, as needed Calibrate unit
Will not calibrate	Dirty electrode Faulty calibration Faulty electrode Faulty wiring to electrode	Clean electrode  Replace electrode if needed Replace wiring if needed
No system power	Check power source Check fuse Check connections	Plug into different receptacle Replace as needed Make sure ribbon cables are secure
Relays not energized	Check fuse Ribbon cable loose Limit time	Replace as needed Reseat ribbon cable between relay and motherboards
Display blank or resetting	Ribbon cable loose	Reseat ribbon cable between display and motherboard at each end
USB not recognized	Ribbon cable loose	Reseat ribbon cable between USB board inside front panel and motherboard

## X. Advantage Controls' Product Warranty

Advantage Controls warrants control systems of its manufacture to be free of defects in material or workmanship. Liability under this policy extends for 24 months from date of installation. Liability is limited to repair or replacement of any failed equipment or part proven defective in material or workmanship upon manufacturer's examination. Removal and installation costs are not included under this warranty. Manufacturer's liability shall never exceed the selling price of equipment or part in question.

Advantage disclaims all liability for damage by its products caused by improper installation, maintenance, use or attempts to operate products beyond their intended functionality, intentionally or otherwise, or any unauthorized repair. Advantage is not responsible for damages, injuries or expenses incurred through the use of its products.

The above warranty is in lieu of other warranties, either expressed or implied. No agent of ours is authorized to provide any warranty other than the above.

### 30 Day Billing Memo Policy

Advantage Controls maintains a unique factory exchange program to ensure uninterrupted service with minimum downtime. If your controller malfunctions, call 1(918)-686-6211, provide our technician with Model and Serial Number information. If they are unable to diagnose and solve your problem over the phone, a fully warranted replacement will be shipped, usually within 48 hours, on a 30-Day Billing Memo. This service requires a purchase order and the replacement is billed to your regular account for payment. The replacement will be billed at current list price for that model less any applicable resale discount. Upon return of your old panel, credit will be issued to your account at either 100% if your unit is in warranty or at 50% if your unit was out of warranty. The exchange covers only the panel. Electrode and enclosure are not included.



# Get the *Advantage* in Municipal Water & Wastewater Equipment!

Advantage Controls can give you the *Advantage* in products, knowledge and support on all of your water/wastewater treatment equipment needs.

- Lift Station & Pump Station Monitors
- Water & Wastewater Site Monitors/Controllers
- Web Monitoring
- Alert/Alarm Notifications
- Water Meters
- Chemical Metering Pumps
- Chemical Solution Tanks
- Chlorine Sensors
- Turbidity Sensors
- Dissolved Oxygen Sensors
- pH & ORP Sensors
- Pre Fabricated Systems

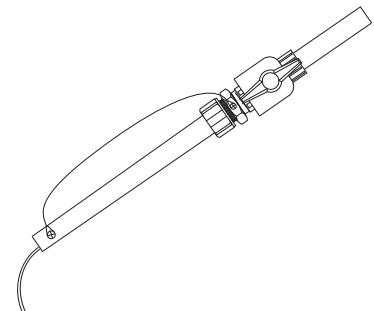
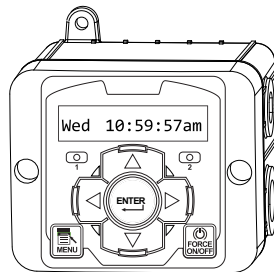
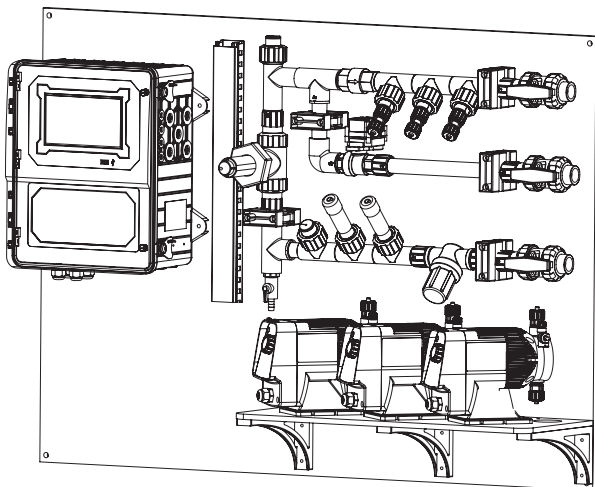
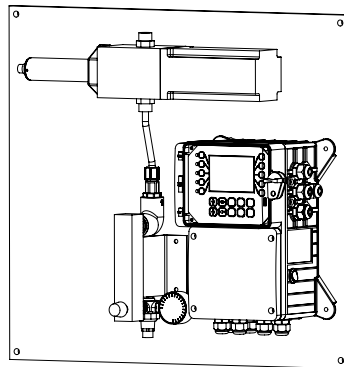
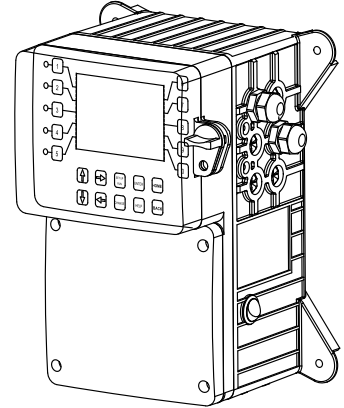
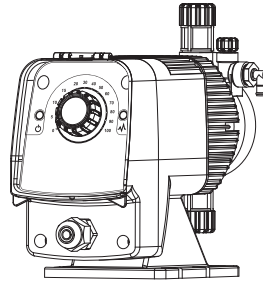

Get the *Advantage*!

**Advantage**  
Controls