



enduroTEQ™

ULTRA-M

Installation Manual



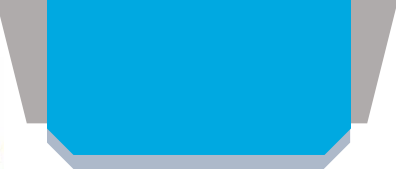

INTRODUCTION

What's in the Box

Bundled package

- Outlet ball valve (3/8" NPT x 3/8" OD Ball Valve)
- Overflow hose barb (1/2" NPT hose barb)
- Toggle anchor (x3)
- 3/16" x 2 1/2" bolts (x3)
- Disc screen
- Disc nozzle (clear)
- Disc diverter



Wall Mount Assembled Unit (configured for bottle use. See instructions below for disc use)

- Reservoir
- Top
- Cover
- Float valve assembly
- Inlet assembly



Additional Items Needed

- Inlet tubing (3/8" OD)
- Outlet tubing (3/8" OD)
- Overflow tubing (1/2" ID)
- Masonry screws 3/16" x 2 1/2" (if installing in solid wall)

Tools Needed

- Drill – 1/2" bit (if using supplied toggle anchors) **OR** 5/32" masonry drill bit (for solid wall)
- Philips screwdriver
- Level
- Tape measure
- PTFE Tape
- 14 mm or 9/16" socket and driver w/ extension (for disc conversion)

SAFETY WARNINGS

- Before working with solid dissolving equipment and chemicals, review SDS for chemical handling procedures.
- Always wear protective clothing and eyewear when working with solid dissolving equipment and chemicals.
- Regularly inspect all tubing for cracking or deterioration. Replace as needed.

GENERAL INSTALLATION CONSIDERATIONS

- All installations should be done in accordance with local plumbing codes and requirements.
- Ensure that dissolver is installed on a structurally sound surface that is able to hold up to 50 lbs.
- Take proper precautions if installing where water hammer is a concern.

DISSOLVER SPECIFICATION

- Weight –
 - 9.6 lbs dry (up to 37.1 lbs with full bottle/4 discs and full reservoir)
 - 4.4 kg dry (up to 16.8 kg with full bottle/4 discs and full reservoir)
- Dimensions –
 - 10.0" w x 23.1" h x 13.2" d (not including solution outlet valve)
 - 25.5cm w x 58.6cm h x 34.6cm d (not including solution outlet valve)
- Maximum incoming water pressure not to exceed 125 psi

EXPLANATION OF SYMBOLS

- Warning - 

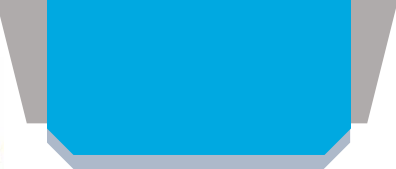

INSTALLATION INSTRUCTIONS

Select location for installation

1. Reference **FIGURE A** for Ultra-M dimensions.
2. NOTE: Be sure to allow extra room above and below the Ultra-M for product loading and tubing hookups.

Locating the wall mount

1. Reference **FIGURE B** for mount dimensions and hole locations.
2. Using a level, draw a vertical center line on the installation location (see below for installing multiple mounts).
3. Line mounting holes on mount with the vertical line.
4. While holding mount in place, mark the 3 hole locations.
5. Remove the mount from wall.

Installing the mount

1. Installing in hollow wall (i.e. drywall not mounted on stud)
 - a. Using a 1/2" drill bit, drill out the wall at the marked locations in previous step.
 - b. Install toggle anchors into holes.
 - i. Hold metal channel flat alongside plastic straps and slide channel through hole.
 - ii. Hold ends of straps between thumb and forefinger and pull toward you until channel rests flush behind wall. Slide plastic cap along straps with other hand until flange of cap is flush with wall.
 - iii. Place thumb between straps at wall. Push thumb side to side, snapping off straps level with flange of cap.
2. Installing on solid wall (i.e. masonry)
 - a. Using a 5/32" masonry drill bit, drill pilot holes into solid wall.
 - b. Place mount over holes with flat side against the wall.
 - c. Insert masonry screws (not supplied) through mount into holes and tighten.

Installing the float

1. Undo the side latches and lift the top of the dissolver up off the reservoir.
2. Using the loop located on top of the float, hook the float to the yoke of the float valve.

3. Place the top of the dissolver back onto the reservoir and engage the latches.

Hang the Ultra-M

1. Lift assembled Ultra-M up and slide down onto mount, allowing the mount to fit in the recessed back portion of the reservoir.
2. Ensure unit is level and plumb.

Connecting water supply

1. Shut off the inlet ball valve located on the top of the inlet assembly.
2. Flush water supply line thoroughly.
3. Connect water supply via 3/8" OD tubing to the inlet assembly by inserting the tubing into the ball valve quick connect. (NOTE: It is recommended to have an inline shutoff valve and serviceable filter located upstream of the Ultra-M).
4. Ensure tubing is completely seated in the fitting.

Connecting solution outlet

1. Using PTFE tape, wrap the threads of the outlet ball valve once.
2. Screw (finger tight) the outlet ball valve into the 3/8" NPT port located on the bottom of the reservoir. (NOTE: be sure to not cross-thread fitting when installing).
3. Insert 3/8" OD tubing into the outlet ball valve.
4. Ensure tubing is completely seated in the fitting.
5. Connect the other end of the tubing to the chemical pump (or equivalent).

Connecting overflow port

1. Using PTFE tape, wrap the threads of the overflow hose barb once.
2. Screw (finger tight) the overflow hose barb into the 1/2" NPT port located on the bottom of the reservoir. (NOTE: be sure to not cross-thread fitting when installing).
3. Slide 1/2" ID tubing onto the hose barb.
4. Route tubing to drain.

Inserting product

1. Bottles
 - a. Shut off water to the dissolver.
 - b. Remove the cover from the Ultra-M and set aside.
 - c. Invert bottle and gently place into product receptacle.
 - i. NOTE: Seals may need to be removed from product before inserting.
 - d. Re-install cover onto Ultra-M and turn on water.



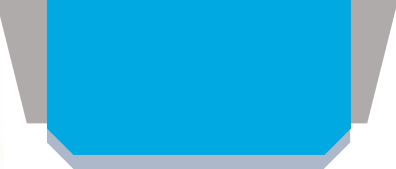

2. Discs

- a. Shut off water to the dissolver.
- b. Remove the cover from the Ultra-M and set aside.
- c. Using a 14mm socket and driver w/ extension, remove the bottle nozzle installed in the Ultra-M.
- d. Install disc nozzle. Do not over-tighten.
- e. Install disc screen with the screen side up.
- f. Remove product disc from packaging and gently slide into product receptacle.
- g. Place the disc cap on top of the installed discs.
 - i. NOTE: Up to 4 discs can be installed at a time
- h. Re-install cover onto Ultra-M and turn on water.

Turning on water

1. Slowly open the ball valve located on the inlet assembly.
2. Open any upstream shutoff valves.

TROUBLESHOOTING

Problem	Potential Causes	Corrective Action
Water not flowing	<ol style="list-style-type: none">1. Upstream supply water is shut off/2. Inlet ball valve is closed.	<ol style="list-style-type: none">1. Open all upstream valves.2. Open inlet ball valve.
Float valve not operating properly	<ol style="list-style-type: none">1. Float is not connected to yoke.2. Unit is not level.3. Faulty float valve assembly.	<ol style="list-style-type: none">1. Connect float to yoke per instructions.2. Reinstall unit so that it is level.3. Replace float valve assembly.
Water is overflowing	<ol style="list-style-type: none">1. Unit is not level.2. Float valve is leaking by.3. External leaks dripping into dissolver.4. Backflow from system.	<ol style="list-style-type: none">1. Reinstall unit so that it is level.2. Replace float valve assembly.3. Check inlet water connection and for overhead leaks.4. Check pump/eductor check valves.

SPARE PARTS

DESCRIPTION	PART NUMBER
Inlet assembly	370557
Inlet valve, 3/8" OD elbow	170551
Outlet valve, 3/8" OD straight	179331
Overflow barb, 1/2" ID	179333
Cover	175001
Disc conversion kit (screen, nozzle, and diverter)	273401
Float valve assembly	370190

INSTALLING MULTIPLE UNITS

When mounting units next to each other, mounts should be installed at least 10 1/2" apart on center from each other.

DIMENSION FIGURES

(for dimensions only)

FIGURE A

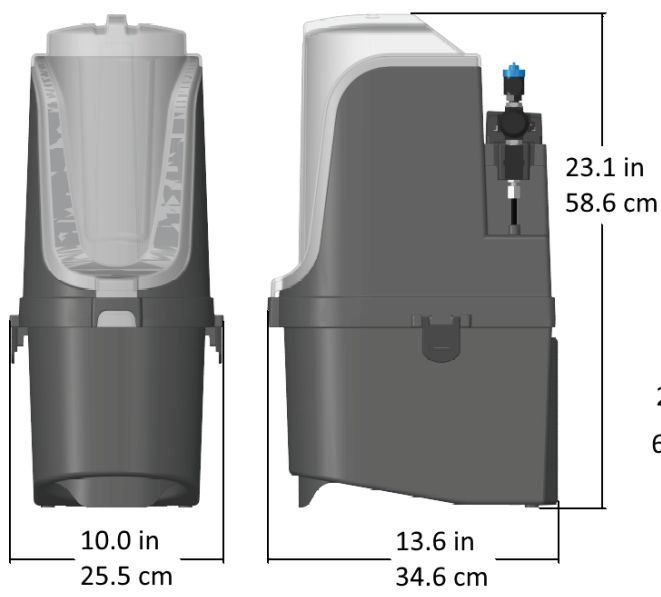
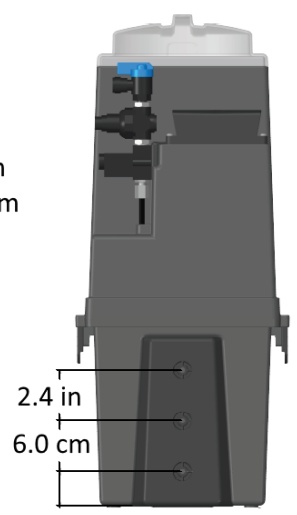
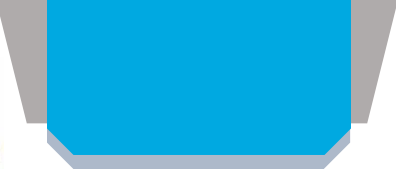

FIGURE B





Disclaimer

The **enduroTEQ Ultra-M** product is provided without any guarantees or warranties, except the Limited Warranty on Parts set forth below. There is no warranty of merchantability, no warranty of fitness for a particular purpose, no warranty of title, and no guarantee of non-infringement of third-party rights. Use of the product by the user is solely at the user's risk.

Limited Warranty

APTech Group, Inc., will provide a one-year Limited Warranty on parts for the **enduroTEQ Ultra-M** from the receipted date of purchase, provided the **enduroTEQ Ultra-M** has been used by the customer only for distribution of APTech's supported products. Upon proper submission of a claim, in writing, for parts or materials, to APTech Group, Inc., accompanied by a receipt for the purchase, dated within a one-year period from the date of the original purchase, new replacement parts will be provided free of charge, subject to shipping and handling costs.

Who we are

APTech Group manufactures solid, concentrated water treatment products for boilers, cooling towers and other water systems. APTech has developed a product to be easier, safer and more environmentally friendly than traditional water treatment products



APTECH

5130 Rialto Rd

West Chester, OH 45069

Phone: 866.489.9831

Email: info@aptechsolids.com

Web: www.aptechgroup.com